



ZapView[®]430 Software Instruction Manual

Doc No: 98-0430-12
Revision B dated 8-July-2020



PHOTON CONTROL USA INC.
900 Calle Plano
Camarillo, CA 93012 USA
PH +1-805-389-6600
support@micronor.com
www.micronor.com

For Support in Europe:
PHOTON CONTROL AG
Pumpwerkstrasse 32
CH-8105 Regensdorf
Switzerland
PH +41-44-843-4020
support@micronor.com

Notice of Proprietary Rights

The design concepts and engineering details embodied in this manual, which are the property of PHOTON CONTROL USA INC., are to be maintained in strict confidence; no element or detail of this manual is to be spuriously used, nor disclosed, without the express written permission of PHOTON CONTROL USA INC. All rights are reserved. No part of this publication may be reproduced, stored in a retrieval system, or transmitted in any form or by any means, electronic, mechanical, photocopying, recording, or otherwise, without prior written permission from PHOTON CONTROL USA INC.

Revision History

Date	REV	Description
04/02/2018	A	Initial Release
6/21/2018	A1	Product release
4/3/2019	A2	Deleted fax number, corrected software title to ZapView 430
7/8/2020	B	Changed to Photon Control

ZapView®430 PC Software for MR430 Series Encoders

System Requirements	PC running Windows 8 or 10, with .NET Framework 4.5 installed
Interface Requirement	USB 2.0 (Controller requires Type B USB connection) or RS232
	NOTE: For RS232 interfaces, use a USB-to-RS232 dongle such as PHOTON CONTROL P/N USB-ADAPTER

PHOTON CONTROL provides ZapView®MR430 software with the MR430 Controller Module to pre-program system parameters associated with the various Auxiliary Functions, such as programming the scale of the analog outputs, or verifying the proper operation of the position sensor system.

The ZapView® software is designed to provide the user with simple but powerful system configuration and monitoring functionality. Refer to the section “ZapView®430 Software Installation Guide” to install the software.

The software was designed with the following areas to enable the user to quickly learn and understand how to configure the system:

PC and ZapView® Configuration

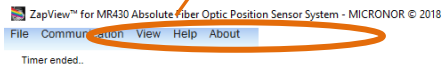

Location of Serial Interfaces (Bottom)

MR 430 Configuration

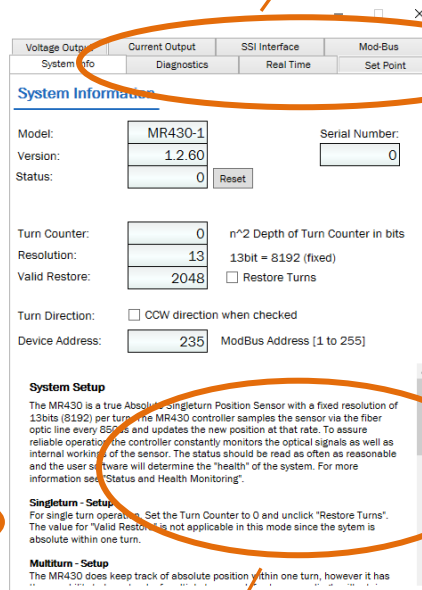

Descriptions and Information

Hover with the mouse over the controls and a brief description will appear. Click and more detail instructions will pop-up as a PDF file in a new window.

Note: If factory support for trouble shooting is required, please save a diagnostic file and send the diagnostic file to the PHOTON CONTROL support person for analysis.

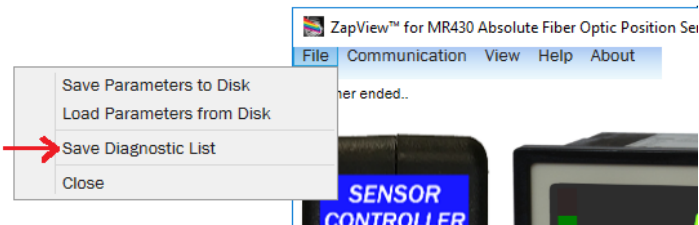

The ZapView®430 software displays the parameters that the MR430 system uses for its operating configuration. The MR430 system has EEPROM storage capability so that if the power is lost, the parameters that have been stored are remembered when the power is restored. When the user changes a setting, ZapView® 430 will remind you to save the setting if the “Enable Save Reminder” is enabled. If you don’t want to save to EEPROM, then ignore the reminder.

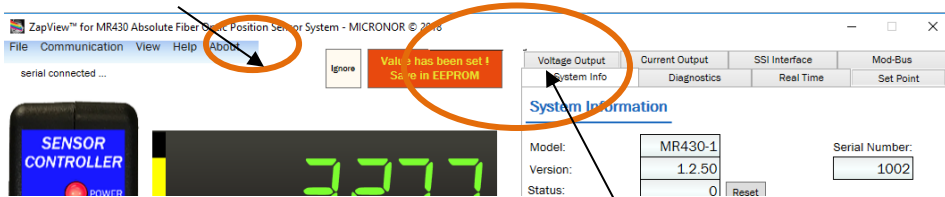

When a setting is changed, to save in EEPROM, just click on the reminder “Save in EEPROM”

Summary of ZapView®430 Command Ribbon:

Command Ribbon	Description
File	Save and Load Parameters to disk - enables quick system duplication
Communications	Configure the address and serial port settings
View	Enable [Save Reminder], [Gauge-Angle], Voltage and Current Meters (digital representation of position)
Help	View the Instruction Manual for the product
About	ZapView® version and software license agreement

Summary of ZapView®430 Configuration Tabs:

Each Tab enables the user to View/Configure the corresponding functions of the MR430 System. Enter the desired value and if the value is within the allowed range, the parameter is sent to the MR430 controller when you press Enter or go to another field. The lower section of each Tab provides information on how to set the respective user configurable parameters of the system.

Tab Heading	Description
System Info	Basic encoder setup – Single Turn resolution, Turn Counter, Modbus device address
Diagnostics	Internal health and diagnostic resources
Real Time	Real time position display and Sensor Pairing mode
Set Point	Set digital Set Point parameters
Voltage Output	Setup voltage output function
Current Output	Setup current output function
SSI Interface	Set SSI baud rate and SSI interface information
Modbus	Set SSI baud rate and Modbus register/command reference

MR430 I/O Configurations

By selecting/clicking on a configurable I/O port, ZapView®430 will automatically go to the appropriate tab for viewing or configuring the respective settings.

By hovering with the mouse over the various controls a short description informs what the control does. By clicking on the labels or control, detailed Information regarding the connections will be displayed.

NOTE:

First time installations of the MR430 Sensor System should have a **Sensor Pairing** Procedure performed. See the **Real Time** Tab for the Pairing Procedure.

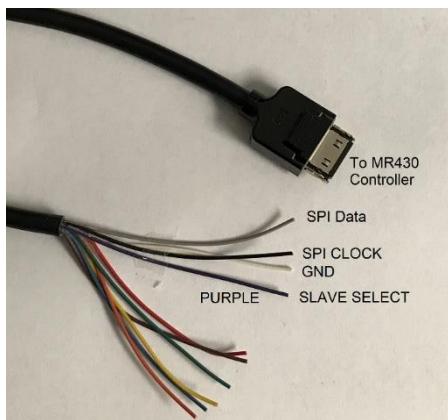

The MR430-99-01 breakout cable allows connections to the MR430 Controller's SSI or RS485 interface.

Photograph of MR430-99-01 SSI/RS485 Connector Pigtail.

ZapView®430 Software Installation Guide

System Requirements	PC running Windows 8 or 10, with .NET Framework 4.5 installed
Interface Requirement	USB 2.0 (Controller requires Type B USB connection) or RS232 NOTE: For RS232 interfaces, use a USB-to-RS232 dongle such as PHOTON CONTROL P/N USB-ADAPTER
Installer File	ZapView_430_Vxx.msi NOTE: if the Windows operating system is Windows 8 or not up to date, the ZapView® Software requires the .NET FRAMEWORK 4.5 to be installed on the PC. Follow the instructions in Step 1 To install the .NET FRAMEWORK 4.5.
Software Location	Supplied ZapView®430 Distribution Media (CDROM or USB Stick) or download from PHOTON CONTROL.com

Installation of ZapView®430 is simple. The Installer will install the necessary files on your PC, follow the steps:

Step 1 Insert the ZapView®430 CD into the CD drive (or other media provided). The program should start automatically if Autoplay is enabled on the PC. If the installation does not start automatically, simply Run the Autoplay.exe program from the root directory of the ZapView® CD. Then Select and Install ZapView®430 Software.

The second option is to run the Setup.exe program from the root directory of the ZapView® CD or storage media.

If you encounter the following error:

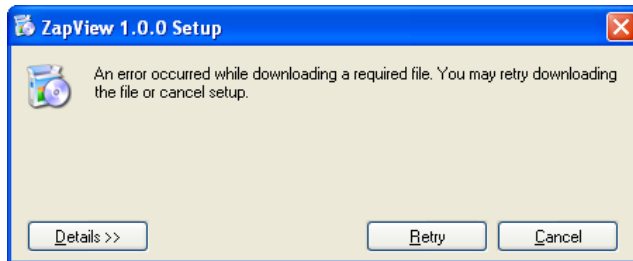

This means that that the required .NET FRAMEWORK 4.5 Client is not installed on the PC. Select Cancel and install the .NET FRAMEWORK 4.5 Client.

To install the .NET FRAMEWORK 4.5 on the PC, run the file "dotNetFx45_Client_x86_x64.exe" found in the Root directory of the ZapView® CD.

When the .NET FRAMEWORK 4.5 installation begins, select "I have read" and "Accept the license agreement" as follows:

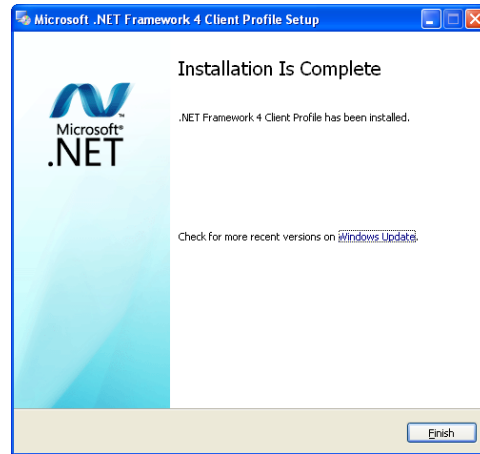
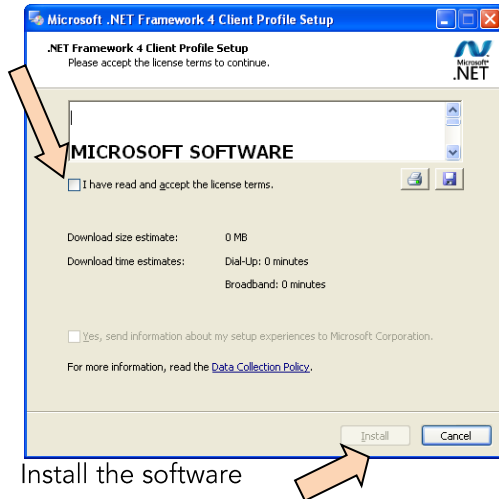

When finished the following message will be displayed.

With the .NET FRAMEWORK 4.5 installed the ZapView® Software can now be installed.

Run the Setup.exe program from the root directory of the ZapView®430 CD or USB Stick.

Step 2 The Installer will guide you through the steps to install the ZapView® Software.

Step 3 Click on **Next>** to continue through the installation.

Step 4 You must Read and Agree with the End User License Agreement to use this Software.

Step 5 The Installer will load the USB driver for the FTDI interface chip on the PC enabling ZapView® to communicate with the MR430 Controller. More information on the USB driver can be viewed on the USB Driver folder on the CD. Or from www.ftdi.com

Step 6 When the Installation is Complete Simply **Close** the Installer.

Step 7 For better performance configure the COM port Latency to 2 ms. This parameter is configured under "Computer Management \ Device Manager \ Ports (COM & LPT)" as shown on the next page.

(NOTE: The COM port needs to be connected and the MR430 Controller must be powered up for the COM to be visible on the PC)

Select the USB Serial Port (COMx) \ Port Settings. Then select Advanced...

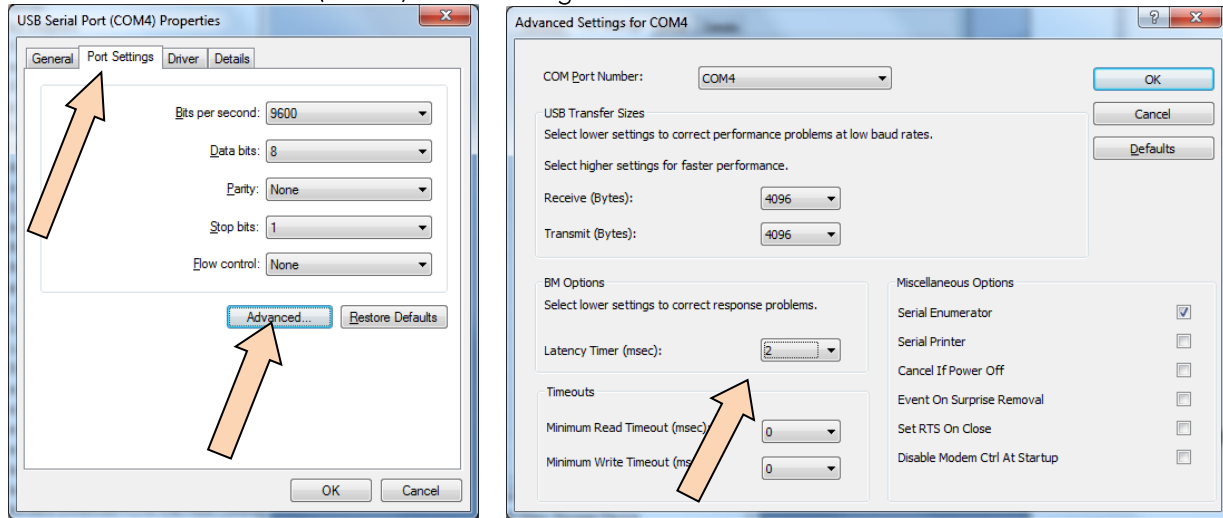

Set 2 for the Latency

Select OK when done.

ZapView®430 is now ready to use.

Start/Run ZapView® by selecting the Desk Top short cut or the Start Menu of Windows 10.

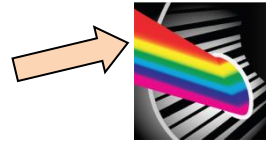

ZapView®430 requires PC connection either via:

- USB port via USB cable with Type B connector for connection to MR430 Controller, or
- RS232 using USB-to-RS232 dongle
- Note COM port assignment for the above connection type used

To start ZapView®430 communicating with the MR430 Controller, click on Communication at the top of the ZapView®430 window.

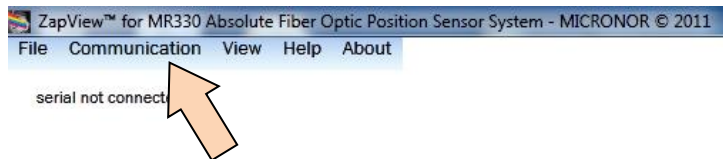

The PC Serial Port Setup window will pop –up:

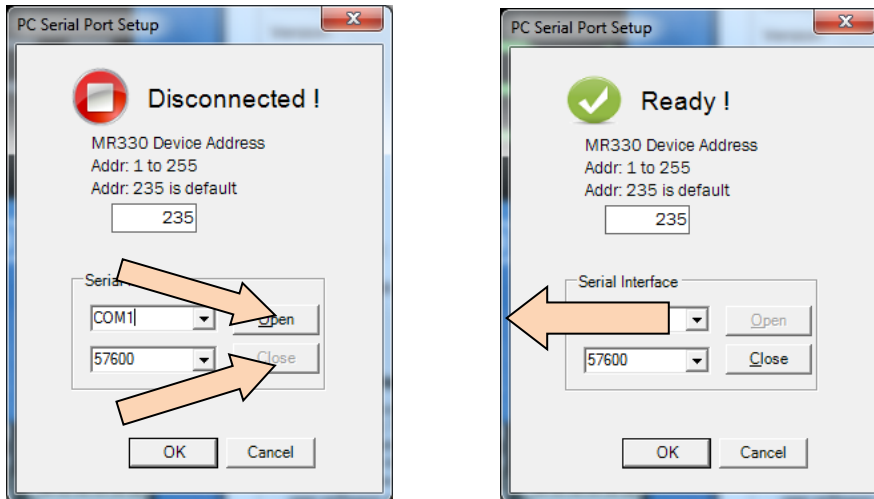

Select the Serial Interface COM port on the PC that is connecting to the MR430 Controller. The baud rate is 57600 (default). After selecting the COM Port and Baud rate, select **Open**.

The PC serial Port Setup will display Ready, when communication is established with the MR430 Controller.

Note: Communications will only be successful if correct COM port and baud rate are selected.

Note: The ZapView®430 instruction manual can be displayed, select Help – ZapView®

